

LF5	LED FLASH BEACON LEDフラッシュビーコン			OUTLINE VIEW 外形図	PROTECTION GRADE 保護等級 IP56	MASS 質量 0.6 kg
	GLOBE COLOUR グローブ色	SOURCE 電源	QUANT./VESS. 数量/1隻	FLASH PATTERN 閃光パターン	CABLE GLAND 電線貫通金物	PAINTING 塗装色
	RED 赤					
	YELLOW 黄					
	GREEN 緑					
	AMBER アンバー					
	BLUE 青					

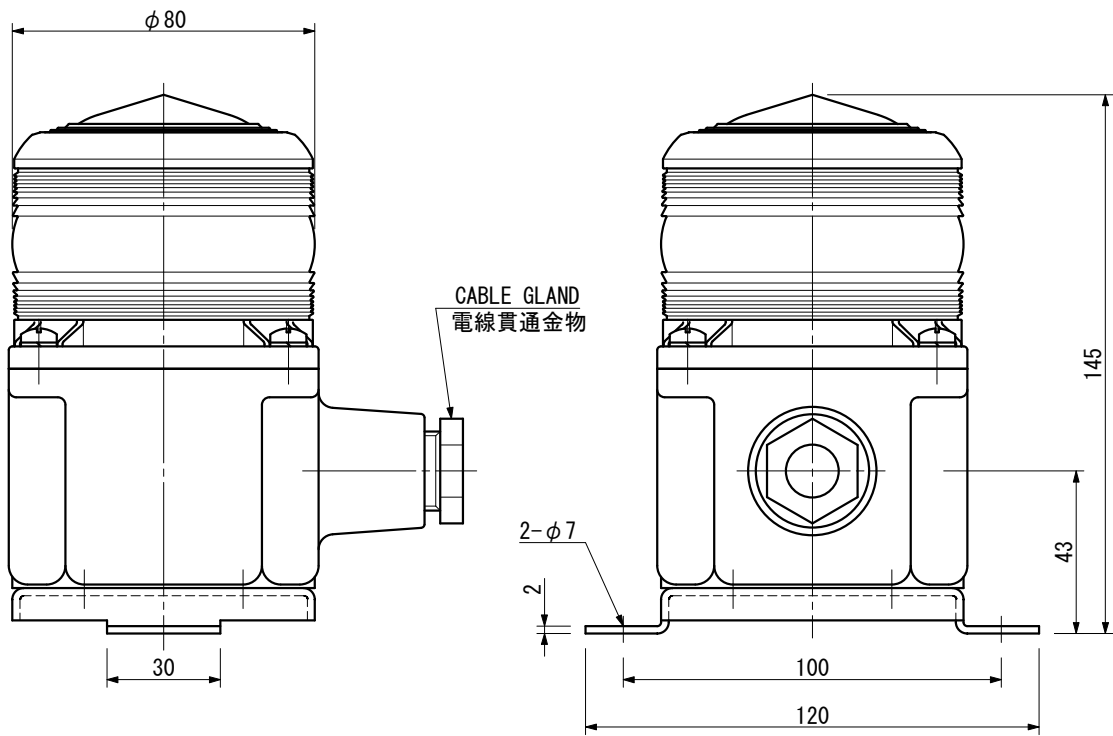

WIRING DIAGRAM
接続図

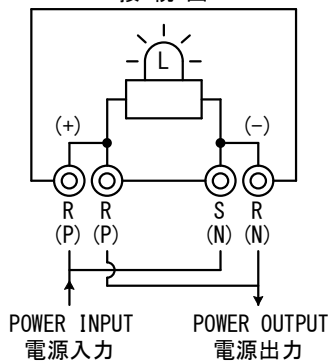

SOURCE 電源	CURRENT 電流	RATING 定格
AC100 V, 1 φ, 60 Hz	60 mA	CONT.
AC220 V, 1 φ, 60 Hz	40 mA	CONT.
DC 24 V	110 mA	CONT.

NO.	DIP SWITCH DIPスイッチ	FLASH PATTERN 閃光パターン	CYCLE 周期
1	ON <input type="checkbox"/> 1 <input type="checkbox"/> 2	NORMAL FLASH ノーマル	120/min
2	ON <input type="checkbox"/> 1 <input type="checkbox"/> 2	RAPID FLASH 高速点滅	240/min
3	ON <input type="checkbox"/> 1 <input type="checkbox"/> 2	FIVE FLASH 5周期点滅	60/min
4	ON <input type="checkbox"/> 1 <input type="checkbox"/> 2	ROTATING LIGHT 回転仕様	130/min

DATE	REV.	REMARKS	IBUKI KOGYO CO. LTD. 伊吹工業株式会社	D. W. N. N. Tanaka	DATE	JUL. -26. 2022
				C. K. D. Y. Ueda	SCALE	1/2
				C. K. D.	DWG. NO	ibk-03010801